

REV

DATE

ENG

DESCRIPTION

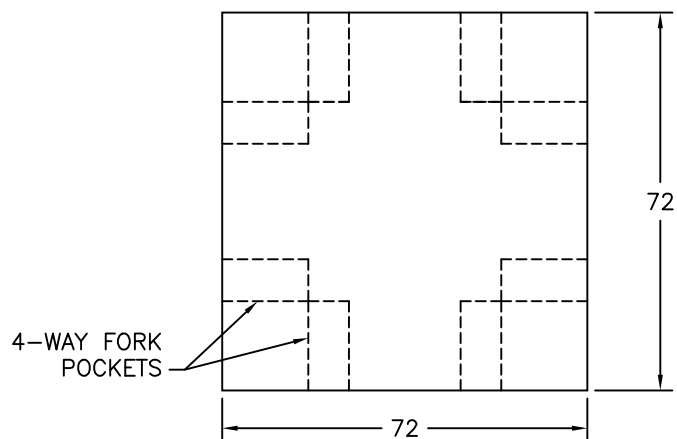
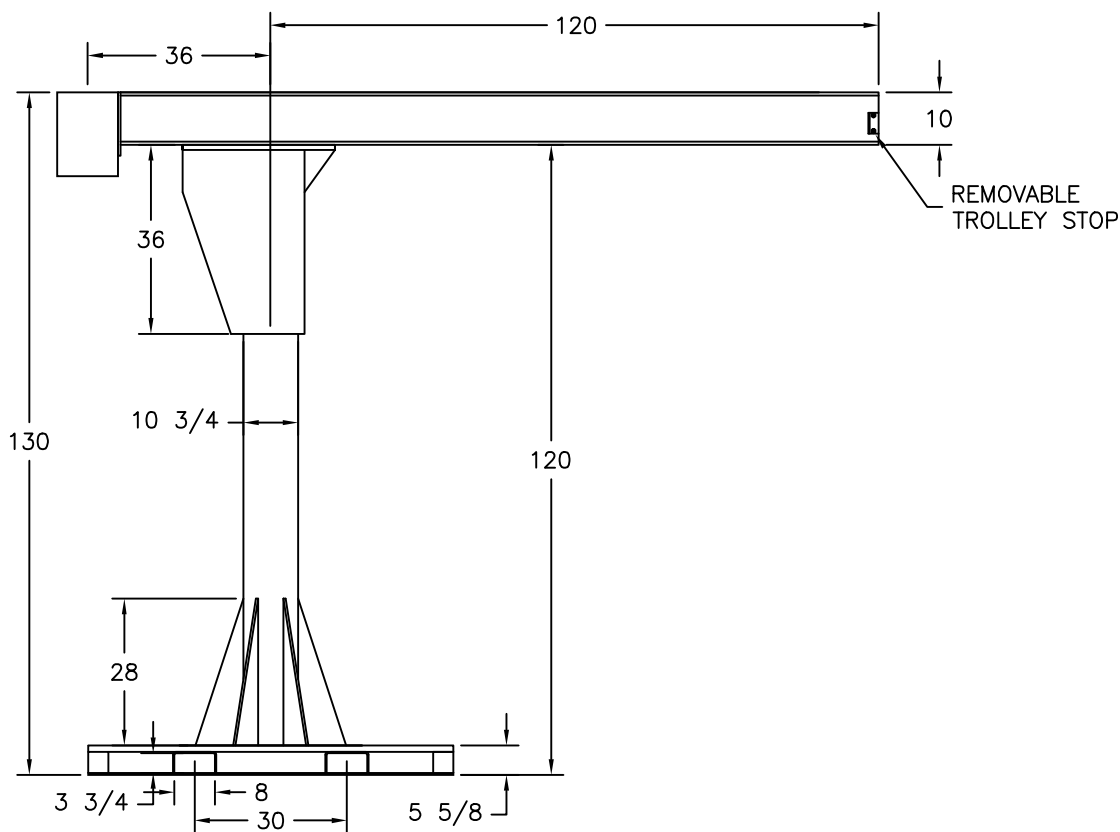

NOTES:

- CAPACITY: 2000 POUNDS
(LESS TROLLEY & HOIST)
- 125% SAFETY FACTOR
FOR STABILITY

Air Technical Industries

7501 CLOVER AVE. - MENTOR, OHIO

TITLE PORTABLE JIB CRANE

JCPRT-21010

DWG. Type LAYOUT

MATERIAL

DRAWN VN

DATE 4/1/2014

SCALE N.T.S.

REVISION -